



Catalogue

BANS AEROSOL

PRODUCTS

Aerosol valve

Actuator

Dispensing pump

Mist sprayer



Contents

- 02** FINE MIST SPRAYER
- 03** LOTION & CREAM PUMP
- 04** TRIGGER SPRAYER
- 05** PERFUME & FOAMER PUMP
- 06** PP-ACRYLIC JARS & BOTTLES
- 07** CAPS & CLOSURES
- 08** PET BOTTLES
- 09** PET & HDPE BOTTLES
- 10** AEROSOL CANS & COMPONENTS
- 11** AEROSOL VALVE & ACTUATORS
- 12** AEROSOL CAPS & CHEMICALS
- 13** AEROSOL MACHINES
- 14** CONSUMER PRODUCTS
- 15** SILICONE & ALLIED PRODUCTS
- 16** INDUSTRIAL SPRAYS
- 17** CAR CARE PRODUCTS



We are specialized in manufacturing and offering a wide range of Fine Mist Sprayer, which is attached with a screw closure Spray Pumps. Our Fine Mist Sprayers are highly suitable for glass and plastic bottles as well as aluminium. These are mainly used for fragrances, personal care, hair care, health care, and air fresheners. Available in standard white & black color, other color can be also customized as per our client's requirements. Further, the closure sizes include 14/410, 16/410, 18/410, 20/410, 22/415, 24/410 and 28/410 (★).



BI-18FW



BI-20FW



BI-24FW



BI-28FW



BI-★FK



BI-★FT



BI-★FB



BI-★FM



BI-★FG



BI-★FP



BI-★FS



BI-★FG



BI-★FS



BI-20ES



BI-20NS



BI-20HS

We are engaged in manufacturing and offering a wide range of Lotion/Cream/Gel Dispenser, which is available in different actuator designs. These are available in various sizes & colors, which give nominal outputs between 1ml to 2ml. Further, these products come in the standardized color of white & Black but can be availed in different colors as per the desired requirements by our valued clients. Further the closures size available include 20/410, 24/410 and 28/410(★).

SCREW SERIES



BI-20LW



BI-24LK



BI-28LO



BI-28LY-R

ON/OFF SERIES



BI-24LW



BI-28LW



BI-24LO



BI-28LS-U



BI-★LS-W



BI-★LY



BI-★LG-T



BI-★LS-K



BI-20CP



BI-24CP1



BI-20CP2



BI-24CP-A

We offer a wide range of Trigger Sprayers, Which is available in different color and more can be customized as per the client's request. Our wide range of trigger sprayers finds its application in different sectors such as domestic, industrial and chemical. These can be perfectly attached with hair care, car care and personal care products. Further, these are widely appreciated for the features like integrated lock to prevent accidental actuation, free rotating closure for orientation on the bottle and High Longevity & High Quality Performance. Further the closures size available include 24/410, 28/400, 28/410.



BI-28TBW



BI-28TYW



BI-28TRW



BI-28TGW

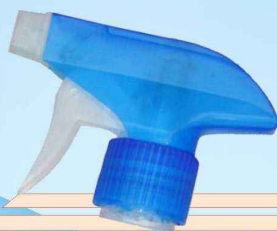

BI-28TBT

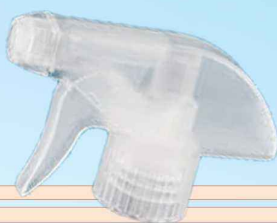

BI-28TT



BI-28TW



BI-28TK



BI-28BBT



BI-28BK



BI-28BTP



BI-28BTG



BI-28CKW



BI-28CK



BI-24FT



BI-28FK

We are engaged in offering a wide range of Perfume Sprayer, which is compact and slim in design. These perfume sprayers come in two colors such as gold and silver, which are designed for fragrances, personal care, health care, and air fresheners. Our wide range of crimp closure spray pumps is highly suitable for glass and plastic bottles as well as roll neck aluminum cans. Further, these gold and silver ferrules are available with different color actuators in plastic or metal sheathed to match. We also offer Pen Sprayer and Foamer pump as per the requirement of the customers.



BI-15PS



BI-20PG



BI-15PSW



BI-20PGW



BI-15PST



BI-15PGK



BI-20PSK



BI-20PGT



Pen Sprayer - 5, 8, 10, 20ml



BI-40FP



BI-48FP



BI-24FP



BI-32FP



BI-28FP



BI-48FP

We are engaged in manufacturing and importing wide range of products like Acrylic Cream jars and lotion bottles, airless pump bottles, PP/PETG bottles and other cosmetic accessory in various size, colour and designs. Our products mainly focus on the cosmetic packages products, which provide the package solution for cosmetics producers worldwide. We provide packaging for many famous cosmetic brands at home and abroad. To assure good quality and production capacity.



BI-101PP



BI-102PP



BI-103PP



BI-201AJ



BI-202AJ



BI-203AJ



BI-204AJ



BI-205AJ



BI-206AJ



BI-207AB



BI-304AB



BI-301AB



BI-302AB



BI-303AB



BI-401PJ

We offer a wide range of caps and closures, which is known for its fantastic functional innovations. Our wide range of caps with different thread size as per bottle requirement is manufactured using high quality basic material, which is procured from reliable vendor spread across the nation. Their salient features are durable finish standard high quality performance, elegant design and smooth finish. Available in different colours as per the requirements by our valued clients.

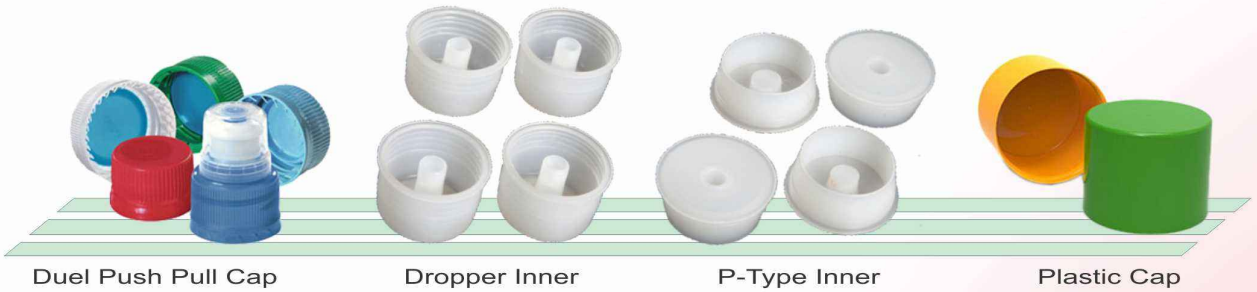

We are engaged in manufacturing and offering a wide range of pet bottles in various sizes and designs these are used in various sectors like cosmetics, personal care, pharmaceutical, household items, insecticides/Pesticides, Auto Products, Cleaning Products. PET bottles come in the standardized colour of white, and transparent but can be availed in different colours as per the desired requirements by our valued clients. Further the closures of the bottle can be customized as per sprayer/pumps or with caps according to the need of our valued customer.



BI-02ASL

BI-12,25,09CLI

BI-022SQ,18BB

BI-04GC



BI-07RB

BI-019SILKI

BI-08SQ

BI-06DW



BI-026JB

BI-12CLI

BI-50HOB

BI-51CRV



BI-52BB

BI-014ZZ

BI-20AVN

BI-53BWP

We are engaged in manufacturing and offering a wide range of HDPE Bottles in various sizes, designs and colour these are used in various sectors like cosmetics, personal care, pharmaceutical, Household Items, insecticides/Pesticides, Auto Products, Cleaning Products. Further, these products come in the standardized colour of white but can be availed in different colours as per the desired requirements by our valued clients.



BI-54



BI-55



BI-56



BI-57



BI-58



Assorted Preforms



BI-59



BI-60



BI-20AVN



BI-101



BI-102



BI-103



BI-104



BI-105



BI-106

We offer an array of aerosol cans and components. Manufactured in accordance with international norms, our entire collection of aerosol cans are known for their features such as leak proof, light weight, unbreakable, resistant to corrosion, light and air proof. These aerosol cans are used in, Spray Paint, Household Items, Industrial Chemicals, insecticides/Pesticides, Auto Products, Cleaning Products, Medicinal Products (like Pain Relievers), Deodorants, Hair-Spray (other Cosmetic Products).

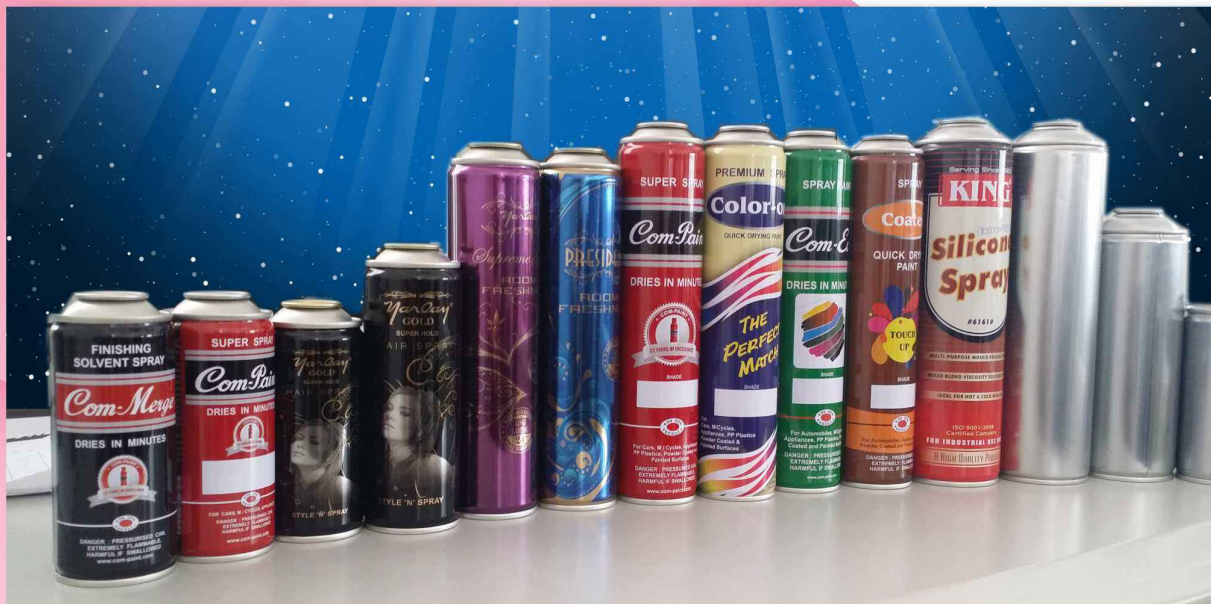

Assorted Neck-In Tin Cans



Assorted Straight Cans

Assorted Aluminium Cans



Top & Bottom for 52mm & 65mm Straight Can

Top & Bottom for 52mm & 65mm Neck-In Can

Top & Bottom

We offer a wide range of Aerosol Valves and actuators, which is known for its fantastic functional innovations. Our wide ranges are manufactured using high quality basic material, which is procured from reliable vendor spread across the world. Different valve and actuator are available for different applications so it is better to inform your exact requirement so that we can recommend suitable Aerosol valve and actuator as per your application.



1" Tinplate Valve



1" Lacqured Valve

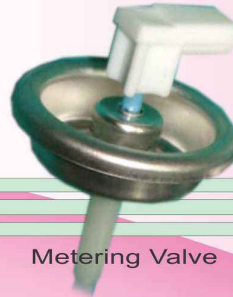

Metering Valve



Butane Valve



Reverse Spray Valve



Lighter Gas Valve



360° Valve



1" Mist Valve



Fan Spray Pattern



Small - 0.4, 0.5, 0.6, 0.7mm



Extn. Tube



Big - 0.4, 0.5, 0.6, 0.7mm



Triangle - 0.4, 0.5, 0.6, 0.7mm



45° Spray

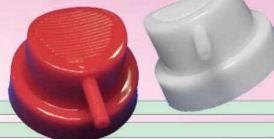

10mm Extn. Tube



Inner Mounting Cup

We offer a wide range of Spray Cap for Aerosol Valves, Which is known for its fantastic functional innovations. Our wide range of spray caps is manufactured using high quality basic material, which is procured from reliable vendor spread across the nation. There salient features are durable finish standard high quality performance, elegant design and smooth finish. Further, these products come in the standardized colour of white & Black but can be availed in different colours as per the desired requirements by our valued clients.



Spray Cap



90° Spray Cap



Trigger Cap
with Extn. Pipe



Brush Cap



Assorted Caps



Spray Cap



65mm Cap



Trigger Cap



Solvent & Oils



Molecular Sieves

The factory has the specialized talented persons who work on producing and serving of aerosol special equipment for many years and it is most perfect processing technology. We know the needs of aerosol industries and develop in our country catching up with advanced technology level of the world as target. Our duty is to provide fine quality and sincere service for vast user. We have different machines as per the production capacity requirement for different industries.

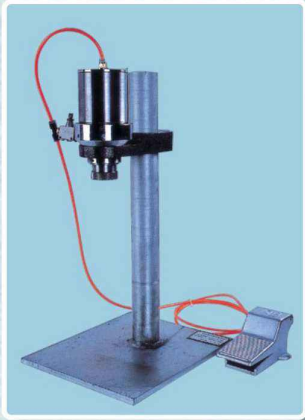

Decrimping Machine

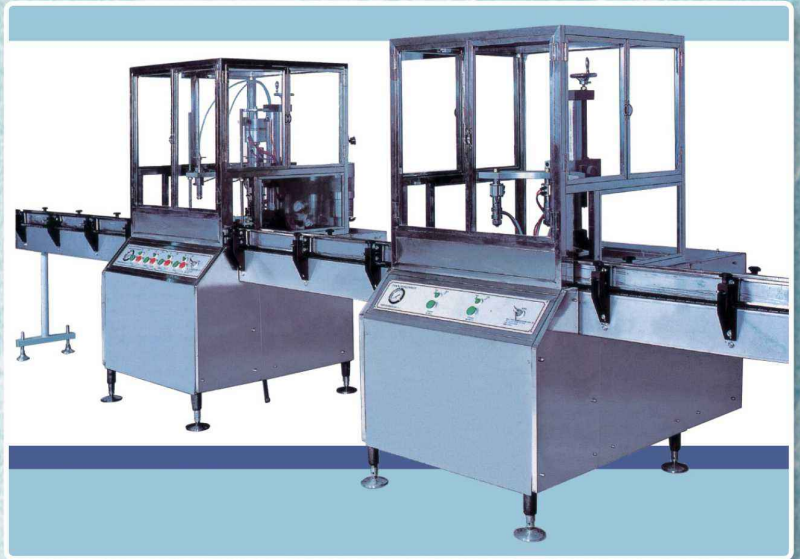

Automatic Spray Bottling Assembly Line

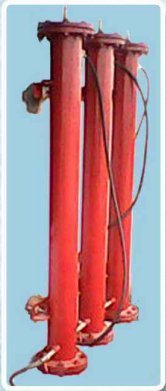

Columns

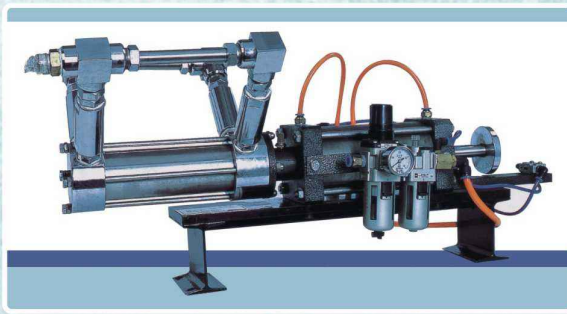

Pneumatic Piston Type Pump



Semi-Automatic Spray Bottling Filling Line



LPG Tank

Serving Since 1983



QUALITY & PERFECTION

BANS AEROSOL

LIGHTER GAS

#1515#



The universal Lighter Gas refill with a metal bottle. It is used to refill the gas of your cigarette lighter. It is available in different design. An injection type to refill general portable lighter. Compact unit for portability & maintenance and it is completely deodorized gas use.

BUTANE GAS

#1919#



We are offering a wide assortment of Butane Gas. Our products are tested rigorously under various quality tests in order to deliver a quality array. They are offered in the market in leak proof packaging. Moreover, they are available at reasonable rates. Used in various commercial applications such as, soldering and machinery cutting.

SNOW SPRAY

#1212#



Spray used in parties to make artificial snow like fall. It looks like snow fall when sprayed. Even colored snow sprays are available and snow spray fights are common. It is commonly used during Christmas, Birthday Parties & New Year Parties. Holi Color Snow Sprays which is available in different colors are occasionally used on Holi festivals by children.

PEPPER SPRAY

#1818#



It's a lachrymatory agent (a chemical compound that irritates the eyes to cause tears, pain, and even temporary blindness) that is used in riot control, crowd control, and personal self-defense, including defense against dogs and bears. It is a less lethal agent that may be harmful in rare cases.

SILICONE FREE SPRAY #6262#



Non-staining, colorless, non-toxic, silicon free compound formulated to provide multiple releases. It prevents sticking of parts in moulds & facilitates easy release. It doesn't transferred to the moulded parts. It's useful where post moulding operations such as painting, plating, embossing, hot-foil stamping, screen or pad printing are required.

SILICONE SPRAY #6161#



Aerosol formulation of silicone fluid propellents and additives on spraying. The fluid is deposited on the surface to which it is applied and thin film of silicone fluid is serviceable from (-49°C) to 200°C & 300°C. It possesses excellent lubricant oxidising and non-carbonising in nature. These properties enable the use of silicone spray as a mould release agent in the moulding operations of plastic & rubber.

METAL DEGREASING #6767#



Specialty cleaner cum degreaser for metal surfaces. It is a cold cleaning solvent based fluid, which dissolves in most waxes, lubricants, dirt, grime, carbon, silicones, tar, etc. It evaporates quickly and does not leave residue. Safe and efficient cleaner for various kinds of metal moulds. It quickly removes residues of release agents, protective coatings, deposits like oil, grease & soil and others.

MOLD/DIE PROTECTOR #6464#



Available in GREEN, RED & CLEAR provides positive protection by displacing moisture form metal surfaces and adhering tightly to the surface. Flows into & protects innermost cavities of molds & dies. Provides superior long & short term protection. Can be directly used over hot molds.

WAX COATING SPRAY #6565#



Primarily used for corrosion and rust prevention. It contains special corrosion resistant waxes and corrosion inhibitors dispersed in a corrosion preventive oil. It leaves a visible coating on the surface to which it is applied. It provides temporary corrosion protection and displacement of moisture from the surface of freshly machined components, bearings, moulds & dies, etc.

SILICONE EMULSION #999#



These emulsions are inert, heat stable, non-toxicity products, which suit many industrial applications where lubrication, gloss, antistatic, protective and release properties are advantageous. Most emulsions are non-ionic as they are compatible with either of the other two systems but depending on the application, cationic or anionic emulsions can be chosen.

SILICONE CREAM POLISH #444#



Highly versatile, easy to use, highly efficient polish in cream & liquid form, useful in removing dirt, ensuring a protective coating and a high gloss film. Used all over by automobiles, TV, Radio, Fan, Refrigeration, Kitchen Tiles, Kitchen Equipment, Furniture, sophisticated Machinery Manufacturers & Floor Polish. Silicone Cream Polish is easy to use and does not require extensive rubbing.

SILICONE GREASE #777#



It's a strong adhesive sealing & white transparent lubricant. Non-melting, constant consistency over wide temperature range upto 200°C. Non-toxic silicon grease for long term lubrication of stop-cocks & valve seals. Lubrication and protection of 'O' rings, rubber seals & plastic parts. The applications includes vacuum and pressure systems, valves, cocks, food processing equipment, chain and open gears, gasket, oil seals & conveyors.

KB-6 MULTI OIL SPRAY #6666#



Special penetrating spray, designed to provide 6 excellent features. It penetrates rusted/jammed assemblies, lubricates mechanisms, displaces moisture from metal surfaces, stops squeaks in moving parts and protects metal surfaces against corrosion. Easy disassembly of frozen, rusted/jammed parts. Cleaning, lubrication, whether protection & noise reduction of locks, hinges, chains, automotive assembly, guns & pistols.

ANTI-SPATTER SPRAY #6363#



It's a spatter release agent, effectively prevents the adhesion of welding spatter on coated surfaces. Easier, cleaner and more cost effective. Enhances life of MIGTIG and TAG tips. It applies on welding wheels & tips, welded surfaces where unsightly spatter build-up is not desired a-need to be post decorated, electrode holders without compromising on user safety.

CARBON REMOVER #7171#



Designed to effectively & safely remove dirt, grease & varnish. Simply spray on, allow to set for 15 minutes & flush with water. It's 100% safe & bio-degradable, non-corrosive & non-staining. Penetrates into the metal for excellent & highly economical de-greasing. It applies on carbon deposits from make-break contractors, relays, commutators, insulators, bus bars. Removes varnishes & adhesives at the time of over hauling.

SAFETY SOLVENT #7272#



No CFC's, non-flammable, non-conductive, non-corrosive, with ultra high di-electric strength, high KB value, fast-drying "on-line" cleaner & de-greaser. Leaves no sticky film, powdery or oily residues. Combination of least toxic, user & workplace friendly solvents. Provides powerful consistent cleaning power.

INSULATING VARNISH #7373#



Thoroughly penetrates into windings & coils and seals out dust and moisture. Designed to be used as a finishing coat over existing impregnating varnishes as well as to provide class-H insulation & protection on unprotected motor surfaces (slots, clamps, plates) so as to enhance the life and reliability of the system as a whole. Also available in green & clear colors.

ELECTRONIC CLEANER #4040#



Fully safe on plastics & metals. Fast cleaning, residue-less, low odor formulation, fully di-electric with mild flux removing action. Excellent "offline" cleaning and flushing action with least possibility of equipment damage.

ANTI-SPATTER GEL #555#



The most effective and economical Production Line Gel available today. Used for torch nozzles in manual operations. Non-flammable, non-toxic, Silicon Free, Odour-less, Convenient to use & has no wastage. Does not cause Porosity. One Dip gives more than 8 hour life.

TREADMILL BELT SPRAY #7575#



Makes the treadmill runs smoothly and not lethargic or jerky. Proper lubrication between the deck and the running belt is essential for good maintenance and years of use. Reducing the friction between the deck and belt reduces wear on the motor and motor controller board. It is recommend to lubricate your treadmill running belt every 40 hours of use or every three months.

CAR AIR FRESHNER #1313#



Sanitize the air in your environment and keep it fresh and fragrant throughout the day. It is ozone friendly since it doesn't contain CFC. Hence, it is totally safe for your health. These fresheners neutralize all the bad odours and leave the environment fragrant. The air freshener can be used in factory environments for industrial odour control. The air freshener are extremely sturdy and last much longer than conventional ones.

DASHBOARD SHINER #1414#



Specially formulated to clean, maintain beauty & protect vinyl, rubber & plastic surface in one easy step. Contains UV defense, helps protect surfaces from fading and cracking caused by damaging UV rays. It's an anti-static agent and reduce dust & dirt attraction, keeping dashboard, vinyl seats and tyres clean & shiny.

PAINT SPRAY #1010#



Used by many industries like Automobiles, White Goods, Handicrafts, Control Panels & Switch Gear manufacturers, Plastic Moulders etc. in their various shades of Cars, Bikes, Washing Machines and Refrigerators for Inplant and Outdoor touch-up purposes. Single coat application give a film thickness of 20 microns and being air drying Paint it touch dries in 3-5 minutes.

MULTI-PRODUCT SHINER #1111#



Give surfaces an "as new" natural look. Non-oily and formulated to help prevent fading and cracking. Revitalizes and enhances the appearance of all vinyl, rubber and plastic surfaces. Treat your products right with King multi-purpose shiner. It provides long-lasting, non-oily protection for both interior and exterior vinyl, plastic and rubber surfaces.

FOAM CLEANER #3030#



Designed to clean glass, plastic & other sensitive surfaces safely, quickly & effectively. It will not allow plastic to crack, yellow & age. Foam cleaner do not contain any toxic chemicals. Simply spray on, allow foam to collapse & wipe/wash off.

CAR WASH #1818#



The shampoo is made of premium quality ingredients and does not harm the paints of the vehicles and dries immediately and restores after cleaning. These shampoo can be used for cleaning alloy rims and rim covers also. Our range can also be used on all kinds of painted surface like scooters, bikes, refrigerators, furniture painted door and walls.

CAR POLISH #1717#



Leaves your auto body ultimately clean leaving no grounds of dust. It's a great shiner. It efficiently aids in maintain the auto body shine for a longer time-period as it acts as a protective coating. These shiners guard car surface from external factors like corrosion, sunlight, and pollution. These are even utilized for removing light oxidation and micro scratches. Oil & Wax Free Formulation.

CHAIN LUBRICANT #5050#



Highly effective lubricant that has good mechanical stability and can penetrate at low temperature into tight inaccessible areas. Offers great resistance to water and high temperature as it is highly tenacious. This solvent carrier gets evaporated and leaves behind an adhesive lubricating film, which provides protection from moisture, dust and corrosive environment.



About US

BANS GROUP of COMPANIES was established in the year 1983. Our founder late Mr. T.C. Bansal had laid foundation of these companies with the vision of giving latest technology and innovative products in cosmetics and aerosol industries. Further our CEO Mr. Girish Bansal (LLB & MBA Marketing) having more than 20 years of expertise in this domain, has taken Bans Group to the new heights and now it's a reputed name in India and abroad. Under his profound guidance, we have earned ourselves a position of repute by providing a range which meets various global standards with his team of loyal and hardworking professionals.

BANS AEROSOL Pvt. Ltd. established in the year 1983, is one of the leaders in manufacturing, exporting and supplying of silicone & allied products, anti-friction preparations, industrial maintenance aerosol products, perfumed and consumable aerosol products. We are an ISO 9001:2008 certified organisation and have won acclaim for manufacturing superlative products at affordable rates.

BANS INTERNATIONAL is the manufacturer and importer of Cosmetic and Pharmaceutical packaging since 2002. We specialize in developing market and sourcing High Quality packaging solutions. Our expertise is extensive, including packaging solutions for Cosmetics, Car Care, Aerosols, Pharmaceuticals, Home Care, Personal Care, Perfumes, Hotel Industry, etc. Product Packaging demands nothing less than the most qualified advice and quality of solution. The decision you make today can be crucial to your products success tomorrow.

BANS & COMPANY is a leading law firm that provides a spectrum of legal services, which include multinational public and private companies and other corporate entities. The firm has a dedicated team of professionals with the specific industry expertise, resources and commitment required to meet all client requirements.

Our innovative solutions will deliver optimum results for your products without changing the way you do things. The quality controllers ensure that the raw material is procured from reliable vendors and all the products are packaged using high grade of packaging material.

Ms. Deepa Bansal
Director



BANS AEROSOL
Private Limited



BANS INTERNATIONAL



BANS & COMPANY

FOR TRADE ENQUIRIES, CONTACT :

Corporate Office :

110, Street No.2, Lalita Park, Laxmi Nagar, Delhi 110 092 Phone: +91-11-2254 6048, 2253 0650
Customer Care: +91 98101 70501 email : sales@bansgroup.com website : www.bansgroup.com, www.bansgroup.in

Factory :

A-137, Sector - 4, Trans Delhi Signature City,
Loni, Ghaziabad - 201 102 (INDIA)

email : info@bansgroup.com, bansaerosol@hotmail.com
website : www.bansgroup.com, www.bansaerosol.com

Factory :

D-71, Sector - A2, Trans Delhi Signature City,
Loni, Ghaziabad - 201 102 (INDIA)

email : sales@bansgroup.com, bansinternational@gmail.com
website : www.bansgroup.in, www.bansinternational.com